

Wiring Centre Series

Model: UH8-RF V2

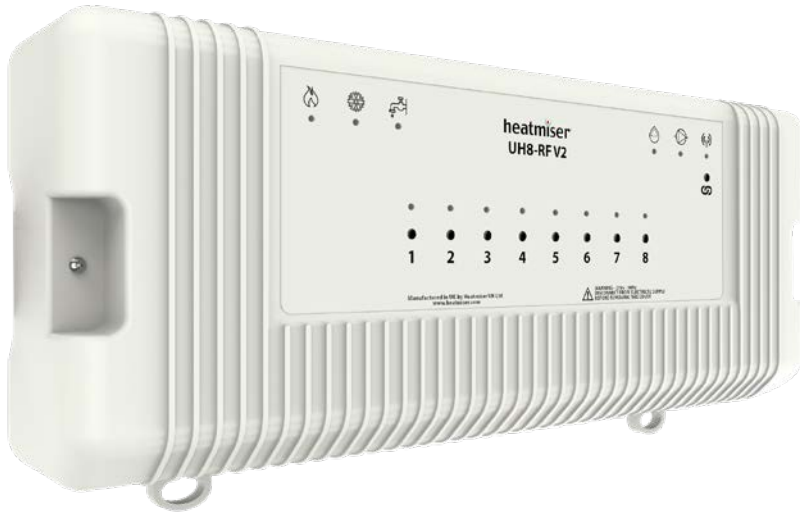

RF-Switch Compatible	Y
Boost Compatible	Y
Slimline-RF Compatible	Y
neoAir V1 & V2 Compatible	Y
Number of heating zones	8
Number of Hot Water Zones	1
Neon Indication	Y
DIN Rail Mounting	Y
Supply	230v AC 50Hz 1 Phase
Relay Load Max	3 Amp Resistive
Total Load Max	5 Amp Resistive
IP Protection	IP20
Installed Dimensions (L,H,D)	384 x 148 x 60mm
Weight	1215g

Wiring Diagram UH8-RF

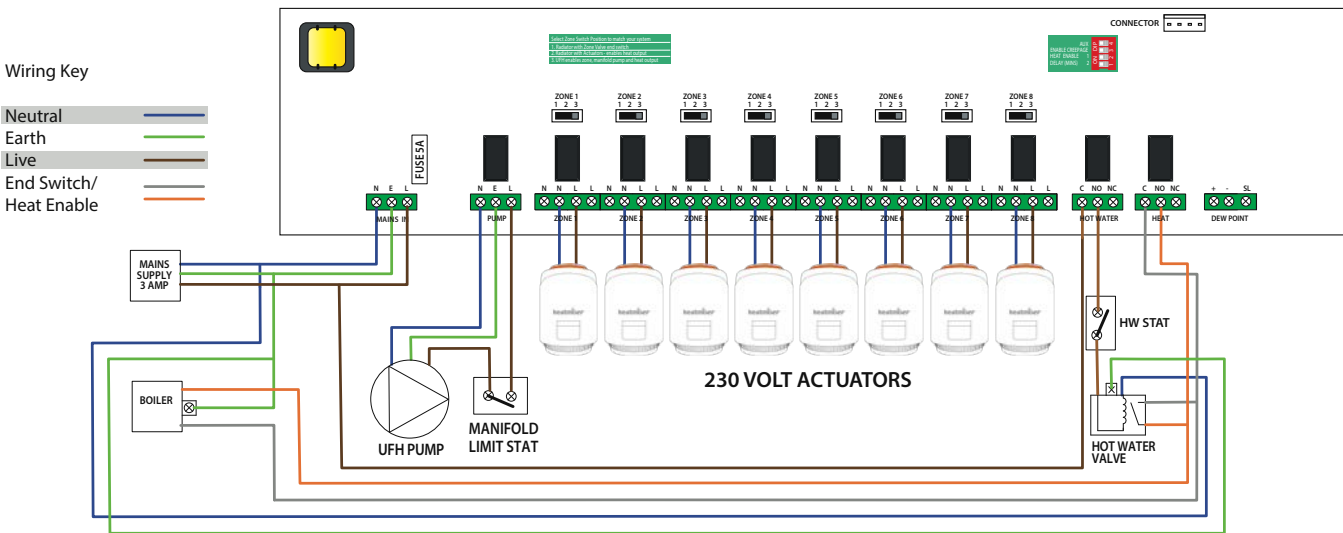

Product Dimensions (mm)

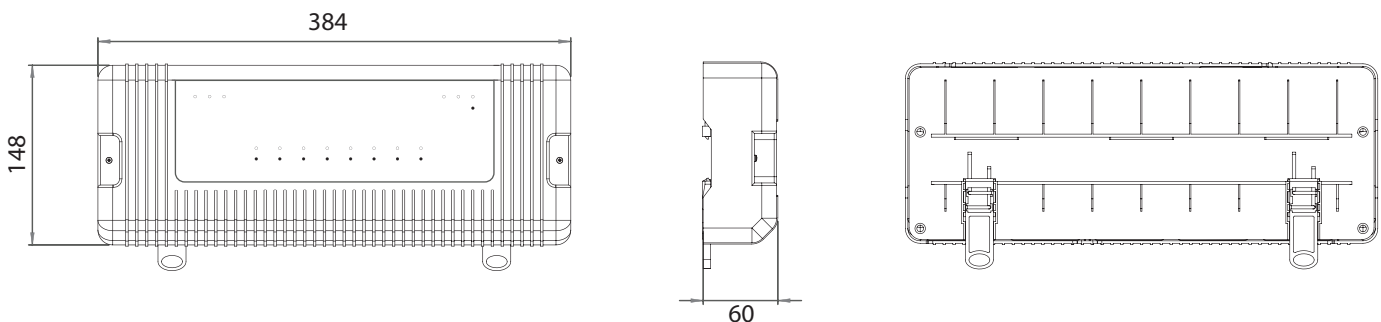

heatmiser®



Model: UH8-RF V2



UH8-RF V2 – Installation Manual

Description

The UH8-RF V2 is an 8 Zone central wiring centre for use with Heatmiser RF thermostats.

The UH8-RF V2 can be used to control any actuator or valve, which requires a 230v AC signal to open. For mid position valves and those requiring a closing signal, a changeover relay is required. The UH8-RF V2 also offers the ability to operate a boiler or other heat source through a volt free output with changeover contacts, giving you both a heat on signal and a heat off signal.

Additional outputs designed for use with hot water or underfloor heating systems, are also included as standard. These are the pump and valve outputs which would normally operate a manifold pump or a manifold valve.

Any output which is not needed can be ignored.

When wiring directly to the heat source is not possible, a radio link is provided to remotely enable a separate receiver, the RF-Switch.

Test switches are included for the installation engineer and further options include creepage protection and pump delay.

Operation

Using the toggle switches, each channel used on this system can be configured for either a radiator zone or underfloor heating zone.

When the thermostat sends a signal for heating, the UH8-RF V2 will provide a 230v AC output on the paired zone and also bring on the boiler/other heat source output. At the same time the UH8-RF V2 can

send a radio signal to the RF-Switch. If the zone is configured as an underfloor heating zone, the UH8-RF V2 will also start the pump and valve outputs.

If an enable signal is received from a hot water time clock on the system, only the H/W output will become active. This is a timed output, which is normally fed to a cylinder thermostat, then to a valve, but could also be used for towel rails. In either case the valve auxiliary switch would operate the boiler/other heat source.

Other functions

Creepage

During hot weather the heating is not normally needed as often, this means that valves and pumps that are not being used can seize and refuse to operate. To prevent this, it is good practice to operate the valve or pump once a day, the creepage function does this for you.

Once enabled the UH8-RF V2 will operate each valve or pump for 1 minute, if the outputs have not been operated by a thermostat, within the preceding 24 hours. This function does not operate the boiler output.

Pump Delay

Some valves or actuators can take more than a minute to open, if the boiler and pump operate before the valve is open it can force a boiler to go to lockout and stop operating. This function delays the operation of the pump and boiler to give the actuators and valves time to open.



Installation

The UH8-RF V2 can be mounted directly to a wall using four screws or alternatively, the unit can be DIN rail mounted.

When DIN Rail mounting, you first need to insert the two clips provided on the back of the UH8-RF V2, as shown in the image;

- On the back of the UH8-RF V2, position the clip in the middle and slide down.
- Points A and B locate in the corresponding holes and lock into place.
- Locate the UH8-RF V2 onto the DIN rail from the top.
- Pull the clip down and push the bottom of the UH8-RF V2 onto the DIN rail.
- Releasing the clip will lock the UH8-RF V2 in place on the DIN rail.

To remove the UH8-RF V2, pull both clips down and remove from the DIN rail.

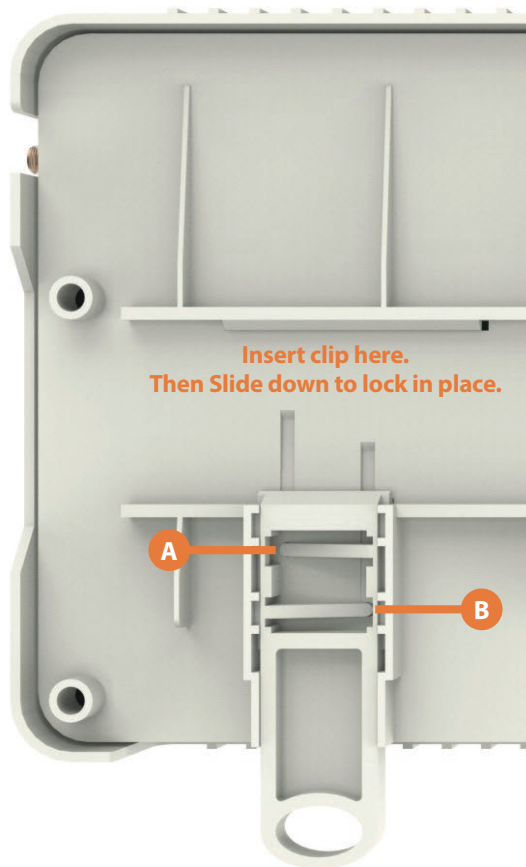



UH8-RF V2 Wiring

The UH8-RF V2 should be fitted as close as possible to the equipment it is controlling, but never within a metal enclosure, if this cannot be avoided an extension antenna (EA1) must be fitted and placed outside the metal enclosure.

Connections

Mains Supply

Power supply into the UH8-RF V2 which should be fused at 5 amps these connections are marked;

L = live or phase 230v AC 50/60Hz

N = Neutral

E = Earth

Heat/Cool Enable

This is the main call for heat for the system, there are 3 connections;

C = common

NO = normally open

NC = normally closed

Electrically this is a two-way switch, whatever supply is placed on the C connection, is fed to the NC connection when there is no call for heat. This is then switched to the NO connection when there is a call for heat.

Most systems will use the common (C) and normally open (NO) connections.

Hot Water

This output is used to control a hot water cylinder thermostat

C = common

NO = normally open

NC = normally closed

Electrically this is a two-way switch, whatever supply is placed on the common connection, is fed to the NC connection when there is no call for hot water. This is then switched to the NO connection when there is a call for hot water.

Hot Water Continued

Normally the NO connection would be wired to the hot water cylinder thermostat, then from there to the hot water valve, the valve auxiliary switch will then start the boiler/other heat source.

Most systems will use the common and normally open connections.

Zones 1...8

Zones outputs are clearly marked

L = live out to actuator or valve

N = neutral to actuator or valve

There are two connections live (L) and neutral (N), both terminals marked L are the same and both terminals marked N are the same.

Each zone output is numbered, Zone 1 will respond to radio signals from the thermostat paired to Zone 1. Zone 2 output will respond to thermostat numbered 2 etc.

Manifold Pump/Valve

Used for an underfloor heating manifold pump and or valve.

Connections are clearly marked

L = Live

E = Earth

N = Neutral

When an under-floor heating zone sends a call for heat to the UH8-RF V2, the live & neutral output will supply 230v to the manifold pump/valve. It is recommended that this is fed through a high limit switch, placed on the heating manifold to protect against mechanical failure of the manifolds temperature control.

Dew Point Sensor (Cooling Mode Only)

Dew Point sensing help to reduce the risk of condensation whilst cooling is in demand.

When activated, the sensor sends a signal back to the UH8-RF V2, and will shutdown cooling to the manifold. During this time, the dew point indicator light will show.

Connections (24 Volt DC)

+ = Positive

- = Negative

SL = Input

Engineers test switches

These are a block of 12 dip switches, used to test each zone, boiler, pump and HW outputs. To enable any output, put the switch in the ON position. When installation is complete all switches MUST be in the OFF position.

Record the rooms names connected to each zone with the zone number and record the channel number you have selected, you will need this information when installing the thermostats.

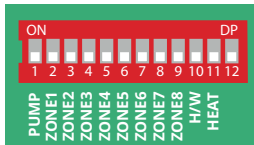

Fuses

5amp, 20mm anti-surge fuse, this fuse supplies power to all 230v outputs from the board, it protects the zone, pump and valve outputs.

Zones 1 to 8 Buttons and indicators

Each Zone has an indicator light and button associated with it.

Light functions:







1. Light on when the zone output is on.
2. Light flashes when the zone is in pairing mode.

Button functions:

1. Single press to manually turn output On/Off.
2. Hold down for 5 seconds to start pairing mode, (Indicator steady flash.)
3. Hold down for 15 seconds to delete pairing, (indicator rapid flash).

System indicators

When lights are on:

- | | | |
|----|---|---|
| 1. | Dew Point - Informs you that cooling has been shut off to prevent condensation. |  |
| 2. | Hot Water- Output is On. |  |
| 3. | Pump Output is On. |  |
| 4. | System is cooling. |  |
| 5. | System is heating. |  |
| 6. | Flashes continous in pairing mode (RF Switch Pairing). Intermittent flashing to indicate communication. |  |



Wiring Diagram UH8-RF Direct Pump Connection

Wiring Key

Neutral	
Earth	
Live	
End Switch/ Heat Enable	

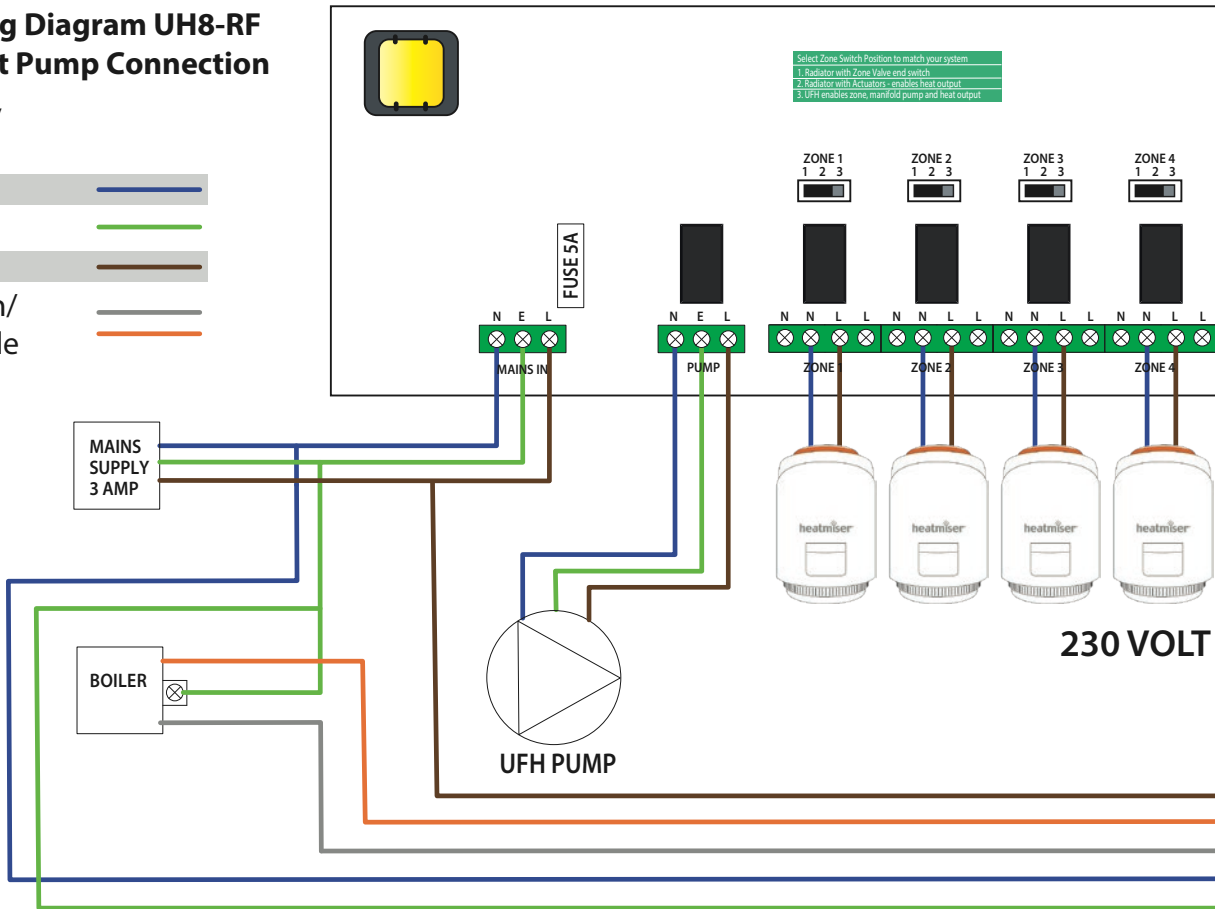

Front Panel Connection

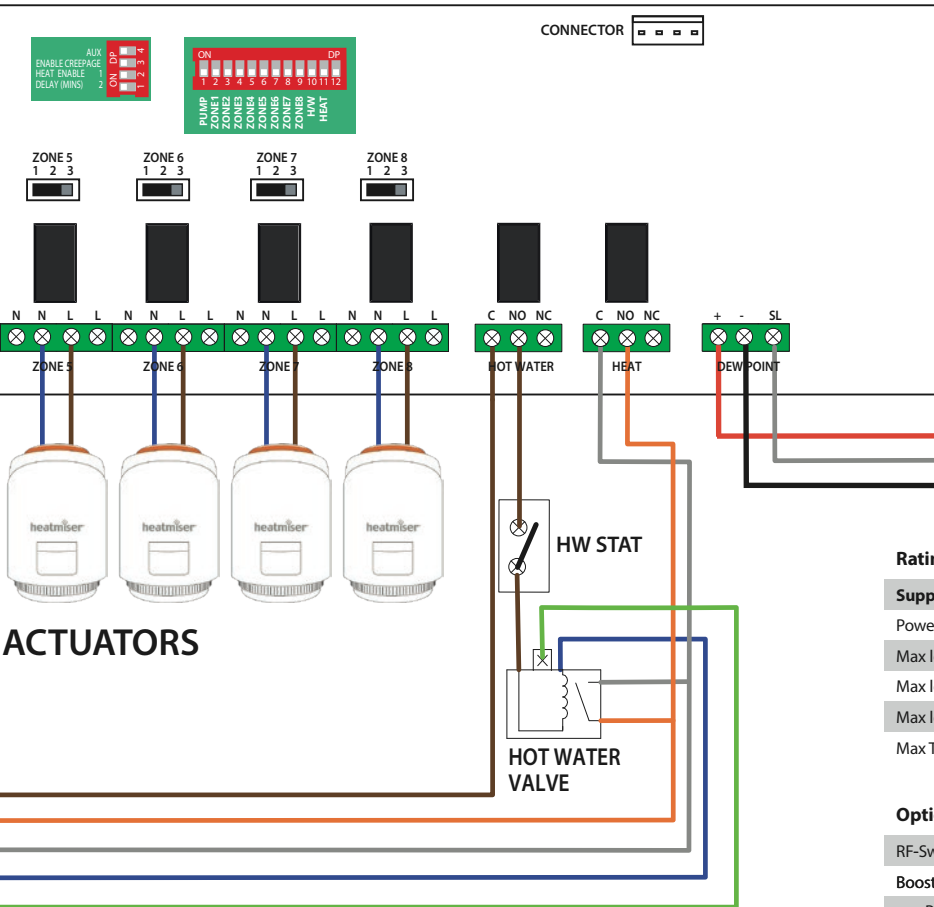

Recommended cable for Dew Point Sensor: Multi-core Screened.

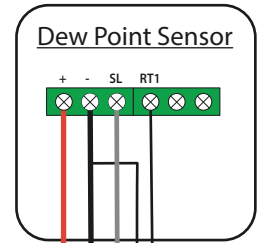

Flow Sensor
Not to exceed 20 meters in cable length!

Ratings

Supply	230v AC 50Hz
Power consumption	7W
Max load on boiler output	3A 230v AC resistive.
Max load on H/W output	3A 230v AC resistive.
Max load for zone outputs	3A 230v AC resistive.
Max Total load	5 Amps

Optional Accessories

RF-Switch	(Remote Boiler enable)
Boost	(Repeater)
neoPlug	(Repeater)
Extension Antenna (included)	(EA1)



Wiring Diagram UH8-RF with UFH & Radiator Valves

Wiring Key

Neutral	
Earth	
Live	
End Switch/ Heat Enable	

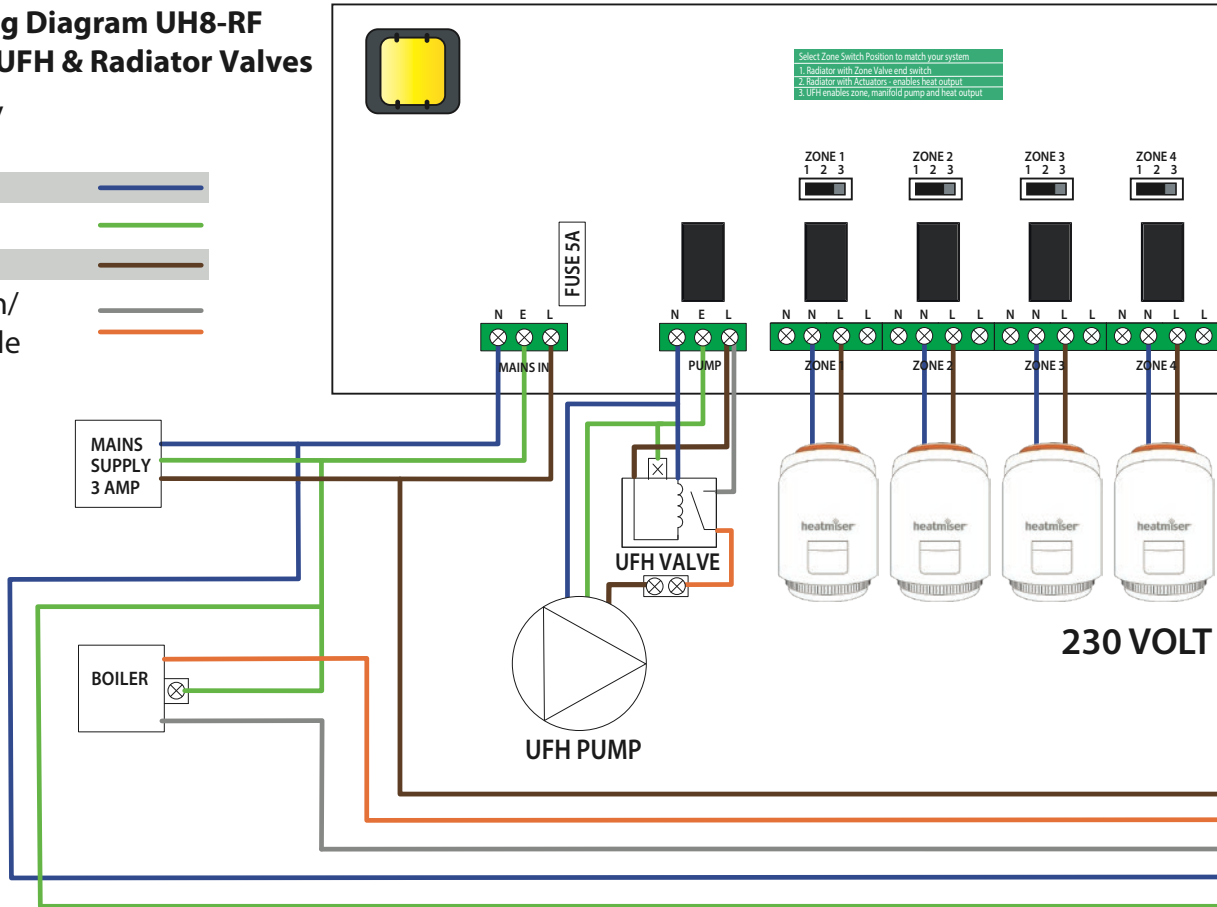

Front Panel Connection

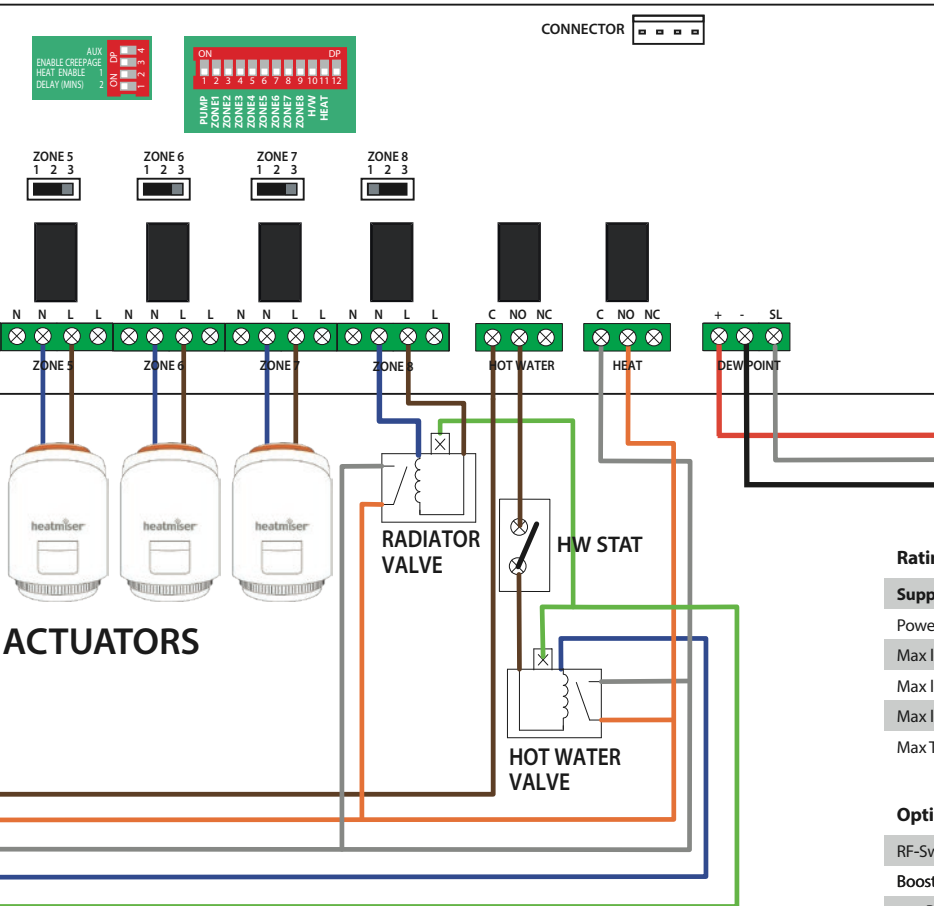

Recommended cable for Dew Point Sensor: Multi-core Screened.

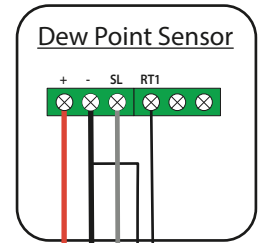

Flow Sensor
Not to exceed 20 meters in cable length!

Ratings

Supply	230v AC 50Hz
Power consumption	7W
Max load on boiler output	3A 230v AC resistive.
Max load on H/W output	3A 230v AC resistive.
Max load for zone outputs	3A 230v AC resistive.
Max Total load	5 Amps

Optional Accessories

RF-Switch	(Remote Boiler enable)
Boost	(Repeater)
neoPlug	(Repeater)
Extension Antenna (included)	(EA1)



System Setup

Zone Type Toggle Switches

There is a 3 position toggle switch above each zone. This switch allows 3 different switched outputs when the thermostat demands heat.

Position 1 - Zone output only.

When a thermostat is in demand, the UH8-RF will activate the Zone output to actuators only, PUMP and HEAT outputs will remain off.



Position 2 - Zone output with heat demand.

When a thermostat is in demand the UH8-RF will activate the zone output to the actuators and heat demand to the boiler.



Position 3 - Zone output with heat demand and manifold pump.

When a thermostat is in demand, the UH8-RF will activate the zone output to the actuators, the heat demand to the boiler and the manifold pump.



Pairing the UH8-RF V2 to the RF-Switch

- On the RF-Switch, press and hold the CH1 pairing button for 5 seconds.
The CH1 status LED will start to flash.
- Press and release the pairing button on the UH8-RF.....🌀
When the RF-Switch detects the pairing signal from the UH8-RF, the CH1 LED will stop flashing.

DIP Switches

There is a 4 way dip switch responsible for 3 functions;

1. Demand RF Test
2. Enable Creepage
3. Heat Enable Delay 1 minute.
4. Heat Enable Delay 2 minutes.

In normal use these DIP switches can be ignored and should be left in the off position.

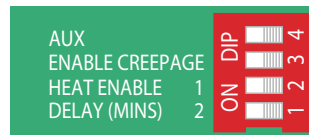

Heat Enable Delay, Dip Switches 1 & 2

Switch 2 ON, Switch 1 OFF = Will delay the heat output for 1 minute.
 Switch 2 OFF, Switch 1 ON = Will delay the heat output for 2 minutes.
 Switch 2 ON, Switch 1 ON = Will delay the heat output for 3 minutes.

Creepage Protection, Dip Switch 3

To enable creepage protection, put switch 3 to the ON position







Slimline-RF V3 Pairing

Step 1, On the UH8-RF V2:

- Press and hold the pairing button on the desired channel until the output indicator LED flashes. Pairing mode is now active on the UH8-RF V2.

Once the UH8-RF V2 detects the pairing signal from the Slimline-RF V3 the output light will turn off.

Step 2, On the Slimline-RF V3:

- Turn Off the thermostat by, holding down the Power button for 3 seconds..... 
- Now hold down the H button for 3 seconds unit you see P1 in the top right hand corner of the display*..... 
- Tap the H button once while P1 is shown to start a 99 second countdown**..... 
- During the countdown the thermostat will transmit a signal and flash the RF icon at the top left hand corner of the display..... 

If pairing is successful, the countdown will jump straight to 00 followed by a blank screen.

- Press the Power button on the thermostat once to turn the unit back On..... 
- If in mode 02, the hot water timer will automatically be paired to the HW channel.*

If pairing is unsuccessful, eliminate a possible signal issue by repositioning the thermostat closer to the receiver and repeat the pairing process again.

**Pairing Menu*









***Active Pairing*







Slimline-RF V1/V2 Setup & Pairing

Step 1 Setup. With the thermostat turned OFF:

- Press & hold the Clock button until you see two sets of numbers appear *..... 
- The small number 01 in the top right corner of the LCD is the feature number.*
- Press Clock repeatedly until you see feature 06 (Receiver Type) 
- The options within feature 06 are: 00 = UH8-RF or 01 = UH8-RF v2/RF-Switch receiver.*
- Use the Up/Down keys to set feature 06 to 01 (UH8-RF V2/RF-Switch) 
- Press Clock again until you see feature 07 (Receiver Address) 
- You can now select a zone number from 01-08. To save confusion, set this address to the same zone number you will be pairing to on the UH8-RF V2. If you have a second UH8-RF V2, you would choose numbers 9 to 16 and so on for each additional wiring centre.*
- Use the Up/Down keys to set feature 07 to 01 
- (You must set a unique zone number address for each thermostat installed).*
- Press A to confirm settings and the display will go blank 
- If in mode 02, the secondary timer will automatically be paired to Hot Water channel.*

Step 2 Pairing.

- On the UH8-RF V2, press and hold the desired zone pairing button for 5 seconds or until the zone light flashes steadily.
- With the thermostat turned OFF, press & hold the A button for 5 seconds..... 
- The thermostat will send a signal for 1 minute and will flash the RF signal icon** 
- If pairing is successful, the flashing light on the UH8-RF V2 will go out almost immediately.*

If pairing is unsuccessful, check features 06 to 07 have been configured correctly. To eliminate a possible signal issue, reposition the thermostat closer to the receiver and repeat the pairing process again.

Note: the maximum number of Slimline-RF thermostats on this system is 32.

*Feature Menu



**Active Pairing





NeoAir Pairing









Applies to NeoAir/NeoAir V2/NeoAir V2M & V3

Step 1, On the UH8-RF V2:







- Press and hold the pairing button on the desired channel until the output indicator LED flashes. Pairing mode is now active on the UH8-RF V2.

Once the neoAir has successfully paired to the UH8-RF V2, the zone light will stop flashing.

Step 2, On the NeoAir V2/V2M/V3:

- Use the Left / Right keys to scroll to the power icon   
- Press and hold the Tick key for 3 seconds..... 
- SETUP will be highlighted*, now press the tick key once..... 
- The display will show 01 in the top right hand corner.*
- Press the Down arrow key once. The display will now show P1..... 
- Press Tick again to start 99 second countdown**..... 
- The thermostat will send a signal for 99 seconds and flash the RF signal icon..... 
- UH8-RF V2: Confirm that the zone light has stopped flashing*
- When pairing is complete, cancel the countdown on the thermostat by pressing the tick key once 

Step 2, On the NeoAir V1:

- Use the Left/Right arrow keys to scroll to SETUP and press tick key once.....   
- The display will show 01 in the top right hand corner.*
- Press the Down arrow key once. The display will now show P1..... 
- Press Tick again to start 99 second countdown**..... 
- The thermostat will send a signal for 99 seconds and flash the mesh symbol..... 
- UH8-RF V2: Confirm that the zone light has stopped flashing*
- When pairing is complete, cancel the countdown on the thermostat by pressing the tick key once 

If in mode 03, the hot water timer will automatically be paired to the HW channel.

If pairing is unsuccessful, eliminate a possible signal issue by repositioning the thermostat closer to the receiver and repeat the pairing process again.

*Setup Menu Entry Point



**Active pairing mode





UH8-RF V2 Title:

	In Use	Zone Type		Zone Title
		Under-Floor	Radiator	
Zone 1	<input type="checkbox"/>	<input type="checkbox"/>	<input type="checkbox"/>	
Zone 2	<input type="checkbox"/>	<input type="checkbox"/>	<input type="checkbox"/>	
Zone 3	<input type="checkbox"/>	<input type="checkbox"/>	<input type="checkbox"/>	
Zone 4	<input type="checkbox"/>	<input type="checkbox"/>	<input type="checkbox"/>	
Zone 5	<input type="checkbox"/>	<input type="checkbox"/>	<input type="checkbox"/>	
Zone 6	<input type="checkbox"/>	<input type="checkbox"/>	<input type="checkbox"/>	
Zone 7	<input type="checkbox"/>	<input type="checkbox"/>	<input type="checkbox"/>	
Zone 8	<input type="checkbox"/>	<input type="checkbox"/>	<input type="checkbox"/>	
Hot Water	<input type="checkbox"/>			



Notes

A series of horizontal dotted lines for writing notes, spanning the width of the page.



Want More Information?

Call our support team on: +44 (0)1254 669090

Or view technical specifications directly on our website:

www.heatmiser.com



PDF



FAQ

Heatmiser UK Ltd
Units 1-5 Hurstwood Court, Mercer Way
Shadsworth Business Park, Blackburn,
Lancashire, BB1 2QU, United Kingdom.

Products Commonly used with the UH8-RF V2 wiring centre.



Slimline-RF



neoAir



RF-Switch/RF-Switch V2



neoPlug (Signal Booster)



TA 230 Actuator