

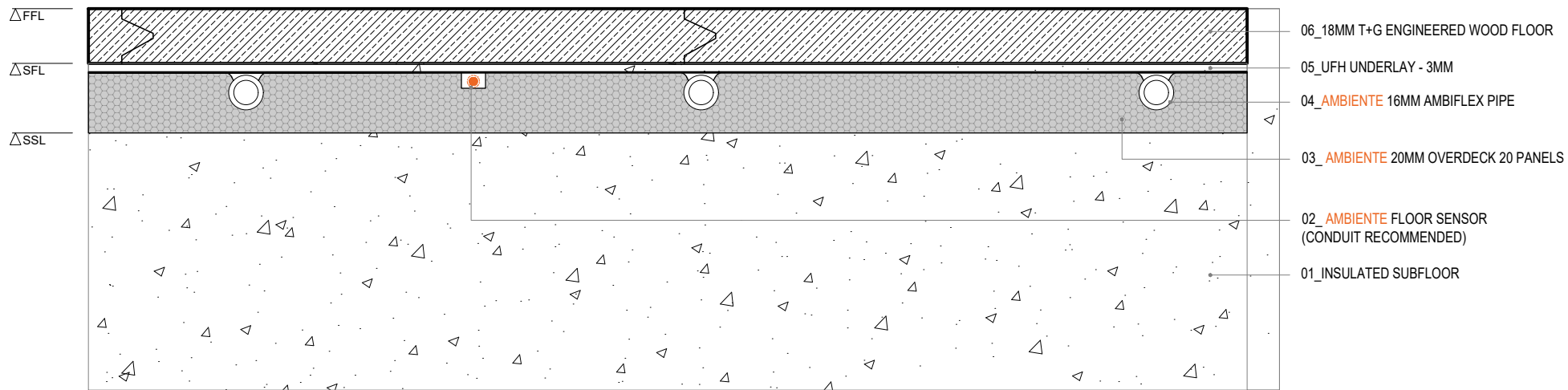

AMBIENTE OVERDECK 20. Standard Floor Detail - Solid Subfloor

TITLE OVERDECK 20 - Standard Floor Detail - Solid Subfloor		CAD FILE 20250804-OVERDECK 20-DET SECTIONS.DWG		 more than underfloor AMBIENTE SYSTEMS LIMITED HERITAGE HOUSE, UNIT 1 WOODSIDE LANE, BELL BAR, HERTFORDSHIRE, AL9 6DE SALES@AMBIENTEUFH.CO.UK T.01707 649 118
DRAWN VL	CHECKED GC	DATE 04.08.2025	SCALE N/A	
<small>THIS FILE AND ITS CONTENT ARE THE PROPERTY OF AMBIENTE SYSTEMS LIMITED AND ARE PROTECTED BY COPYRIGHT LAWS. THIS FILE AND ITS CONTENTS MAY ONLY BE DISTRIBUTED, COPIED OR REPRODUCED IN FULL AND MAY NOT BE EDITED OR COPIED IN PART. DO NOT SCALE FROM THIS DRAWING.</small>				



AMBIENTE OVERDECK 20. Wood Floor Detail - Solid Subfloor

TITLE OVERDECK 20 - Wood Floor Detail - Solid Subfloor		CAD FILE 20250804-OVERDECK 20-DET SECTIONS.DWG		 more than underfloor <small>AMBIENTE SYSTEMS LIMITED HERITAGE HOUSE, UNIT 1 WOODSIDE LANE, BELL BAR, HERTFORDSHIRE, AL9 6DE SALES@AMBIENTEUFH.CO.UK T.01707 649 118</small>
DRAWN VL	CHECKED GC	DATE 04.08.2025	SCALE N/A	
<small>THIS FILE AND ITS CONTENT ARE THE PROPERTY OF AMBIENTE SYSTEMS LIMITED AND ARE PROTECTED BY COPYRIGHT LAWS. THIS FILE AND ITS CONTENTS MAY ONLY BE DISTRIBUTED, COPIED OR REPRODUCED IN FULL AND MAY NOT BE EDITED OR COPIED IN PART. DO NOT SCALE FROM THIS DRAWING.</small>				

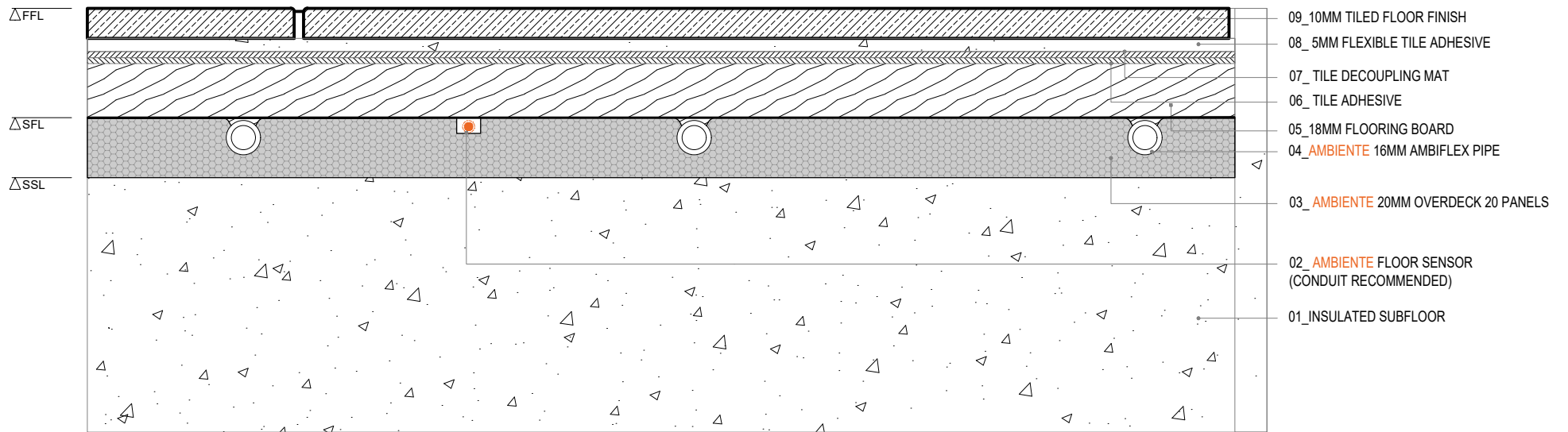

AMBIENTE OVERDECK 20. Tiled Floor Finish - Solid Subfloor

TITLE OVERDECK 20 - Tiled Floor Finish - Solid Subfloor		CAD FILE 20250804-OVERDECK 20-DET SECTIONS.DWG		 more than underfloor AMBIENTE SYSTEMS LIMITED HERITAGE HOUSE, UNIT 1 WOODSIDE LANE, BELL BAR, HERTFORDSHIRE, AL9 6DE SALES@AMBIENTEUFH.CO.UK T.01707 649 118
DRAWN VL	CHECKED GC	DATE 04.08.2025	SCALE N/A	
<small>THIS FILE AND ITS CONTENT ARE THE PROPERTY OF AMBIENTE SYSTEMS LIMITED AND ARE PROTECTED BY COPYRIGHT LAWS. THIS FILE AND ITS CONTENTS MAY ONLY BE DISTRIBUTED, COPIED OR REPRODUCED IN FULL AND MAY NOT BE EDITED OR COPIED IN PART. DO NOT SCALE FROM THIS DRAWING.</small>				

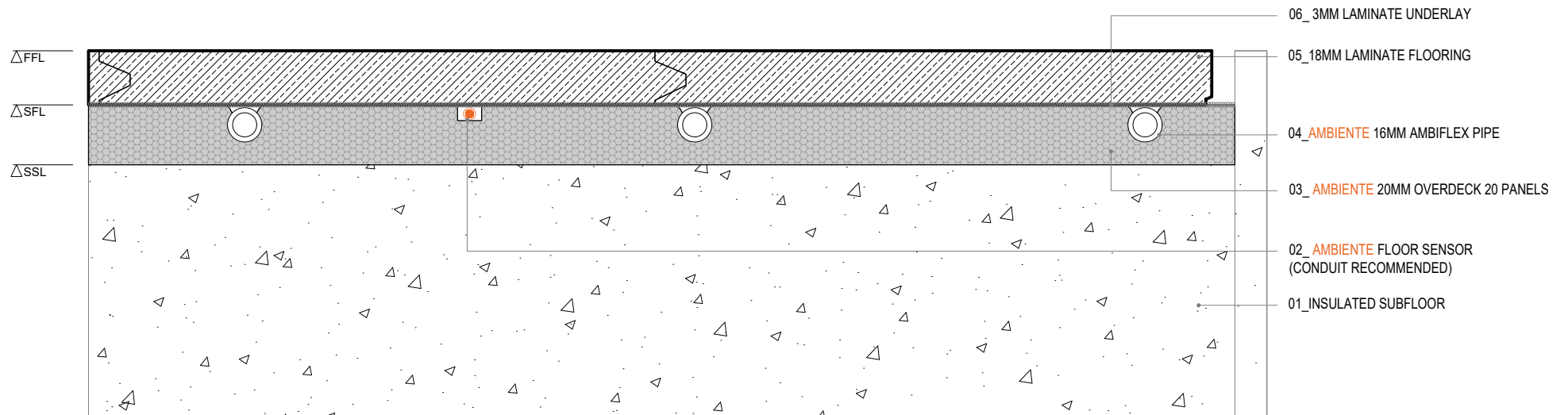

AMBIENTE OVERDECK 20. Laminate Floor Detail - Solid Subfloor

TITLE OVERDECK 20 - Laminate Floor Detail - Solid Subfloor		CAD FILE 20250804-OVERDECK 20-DET SECTIONS.DWG	
DRAWN VL	CHECKED GC	DATE 04.08.2025	SCALE N/A

THIS FILE AND ITS CONTENT ARE THE PROPERTY OF AMBIENTE SYSTEMS LIMITED AND ARE PROTECTED BY COPYRIGHT LAWS. THIS FILE AND ITS CONTENTS MAY ONLY BE DISTRIBUTED, COPIED OR REPRODUCED IN FULL AND MAY NOT BE EDITED OR COPIED IN PART.
DO NOT SCALE FROM THIS DRAWING.



AMBIENTE SYSTEMS LIMITED
HERITAGE HOUSE, UNIT 1 WOODSIDE LANE, BELL BAR, HERTFORDSHIRE, AL9 6DE
SALES@AMBIENTEUFH.CO.UK
T.01707 649 118

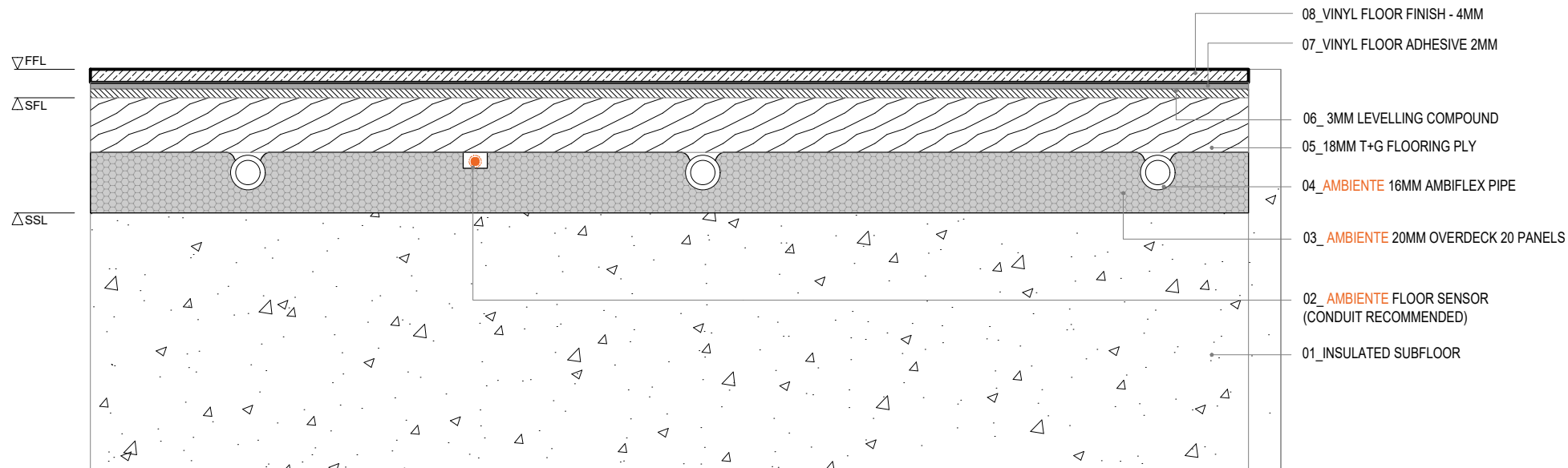

AMBIENTE OVERDECK 20. Vinyl Floor Finish - Solid Subfloor

TITLE OVERDECK 20 - Vinyl Floor Finish - Solid Subfloor		CAD FILE 20250804-OVERDECK 20-DET SECTIONS.DWG	
DRAWN VL	CHECKED GC	DATE 04.08.2025	SCALE N/A
<small>THIS FILE AND ITS CONTENT ARE THE PROPERTY OF AMBIENTE SYSTEMS LIMITED AND ARE PROTECTED BY COPYRIGHT LAWS. THIS FILE AND ITS CONTENTS MAY ONLY BE DISTRIBUTED, COPIED OR REPRODUCED IN FULL AND MAY NOT BE EDITED OR COPIED IN PART. DO NOT SCALE FROM THIS DRAWING.</small>			



AMBIENTE SYSTEMS LIMITED
 HERITAGE HOUSE, UNIT 1 WOODSIDE LANE, BELL BAR, HERTFORDSHIRE, AL9 6DE
 SALES@AMBIENTEUFH.CO.UK
 T.01707 649 118

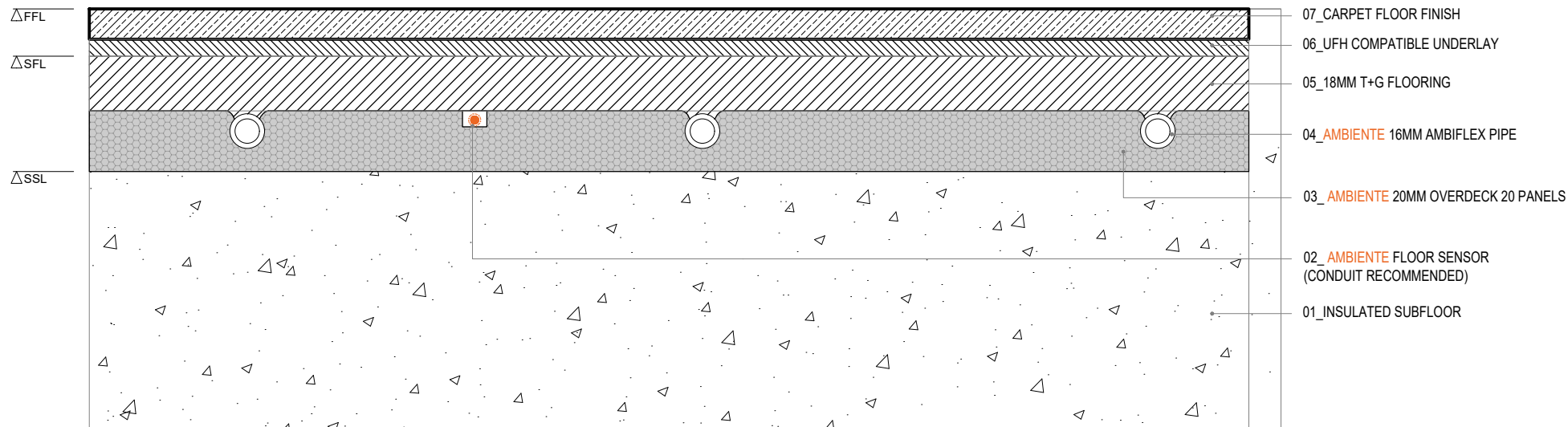

AMBIENTE OVERDECK 20. Carpet Floor Finish - Solid Subfloor

TITLE
OVERDECK 20 - Carpet Floor Finish - Solid Subfloor

CAD FILE
20250804-OVERDECK 20-DET SECTIONS.DWG

DRAWN
VL

CHECKED
GC

DATE
04.08.2025

SCALE
N/A



more than underfloor

AMBIENTE SYSTEMS LIMITED
 HERITAGE HOUSE, UNIT 1 WOODSIDE LANE, BELL BAR, HERTFORDSHIRE, AL9 6DE
 SALES@AMBIENTEUFH.CO.UK
 T.01707 649 118

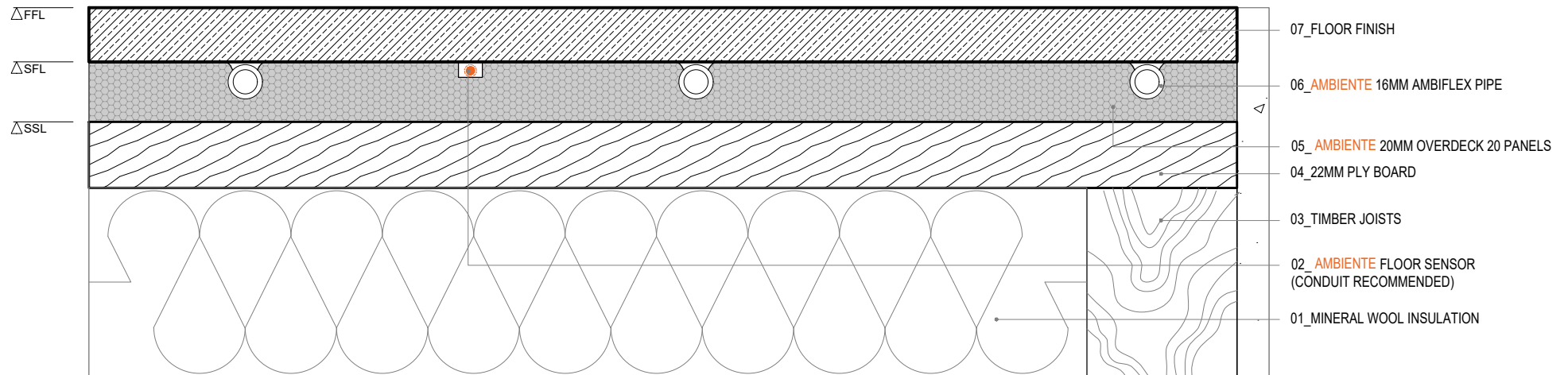

AMBIENTE OVERDECK 20. Standard Floor Detail - Timber Subfloor

TITLE OVERDECK 20- Standard Floor Detail - Timber Subfloor		CAD FILE 20250804-OVERDECK 20-DET SECTIONS.DWG		 <p>ambiente more than underfloor</p> <p>AMBIENTE SYSTEMS LIMITED HERITAGE HOUSE, UNIT 1 WOODSIDE LANE, BELL BAR, HERTFORDSHIRE, AL9 6DE SALES@AMBIENTEUFH.CO.UK T.01707 649 118</p>
DRAWN VL	CHECKED GC	DATE 04.08.2025	SCALE N/A	
<small>THIS FILE AND ITS CONTENT ARE THE PROPERTY OF AMBIENTE SYSTEMS LIMITED AND ARE PROTECTED BY COPYRIGHT LAWS. THIS FILE AND ITS CONTENTS MAY ONLY BE DISTRIBUTED, COPIED OR REPRODUCED IN FULL AND MAY NOT BE EDITED OR COPIED IN PART. DO NOT SCALE FROM THIS DRAWING.</small>				

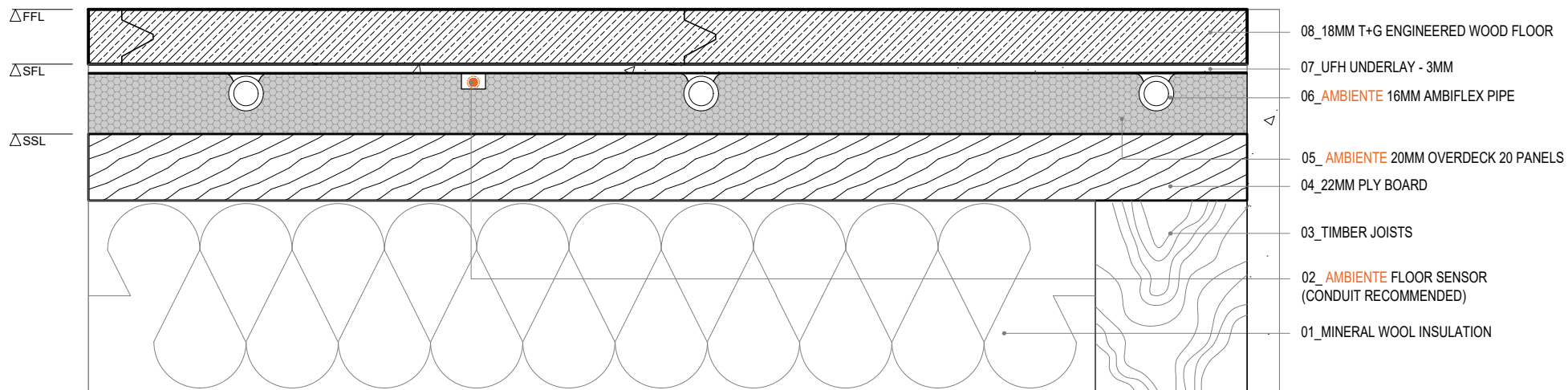

AMBIENTE OVERDECK 20. Wood Floor Detail - Timber Subfloor

TITLE OVERDECK 20- Wood Floor Detail - Timber Subfloor		CAD FILE 20250804-OVERDECK 20-DET SECTIONS.DWG		 ambiente more than underfloor <small>AMBIENTE SYSTEMS LIMITED HERITAGE HOUSE, UNIT 1 WOODSIDE LANE, BELL BAR, HERTFORDSHIRE, AL9 6DE SALES@AMBIENTEUFH.CO.UK T.01707 649 118</small>
DRAWN VL	CHECKED GC	DATE 04.08.2025	SCALE N/A	
<small>THIS FILE AND ITS CONTENT ARE THE PROPERTY OF AMBIENTE SYSTEMS LIMITED AND ARE PROTECTED BY COPYRIGHT LAWS. THIS FILE AND ITS CONTENTS MAY ONLY BE DISTRIBUTED, COPIED OR REPRODUCED IN FULL AND MAY NOT BE EDITED OR COPIED IN PART. DO NOT SCALE FROM THIS DRAWING.</small>				

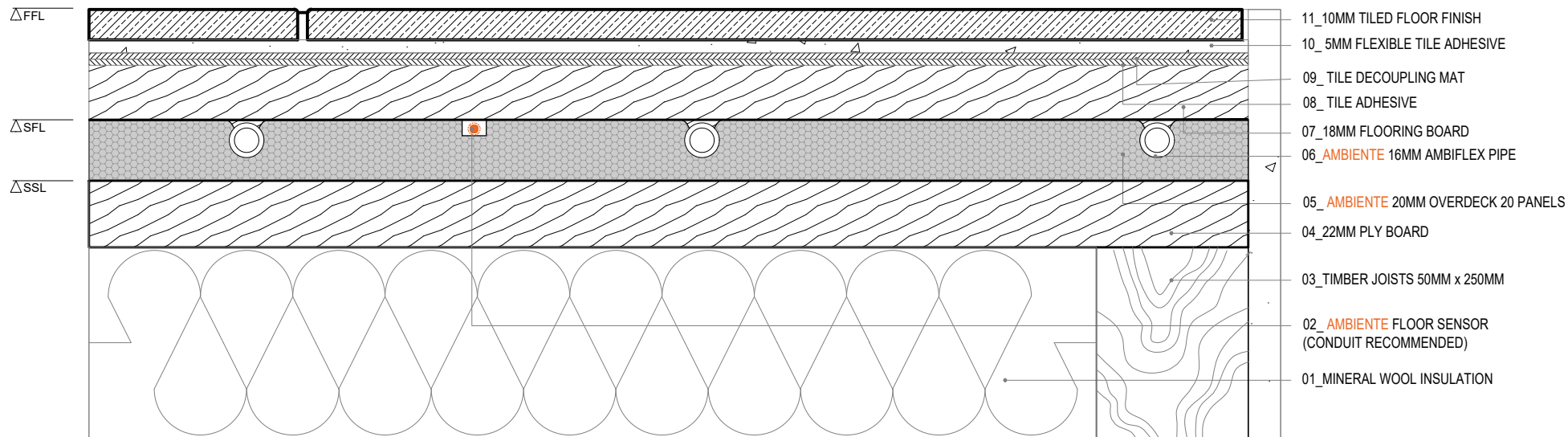

AMBIENTE OVERDECK 20. Tiled Floor Finish - Timber Subfloor

TITLE OVERDECK 20 - Tiled Floor Finish - Timber Subfloor		CAD FILE 20250804-OVERDECK 20-DET SECTIONS.DWG		 ambiente more than underfloor <small>AMBIENTE SYSTEMS LIMITED HERITAGE HOUSE, UNIT 1 WOODSIDE LANE, BELL BAR, HERTFORDSHIRE, AL9 6DE SALES@AMBIENTEUFH.CO.UK T.01707 649 118</small>
DRAWN VL	CHECKED GC	DATE 04.08.2025	SCALE N/A	
<small>THIS FILE AND ITS CONTENT ARE THE PROPERTY OF AMBIENTE SYSTEMS LIMITED AND ARE PROTECTED BY COPYRIGHT LAWS. THIS FILE AND ITS CONTENTS MAY ONLY BE DISTRIBUTED, COPIED OR REPRODUCED IN FULL AND MAY NOT BE EDITED OR COPIED IN PART. DO NOT SCALE FROM THIS DRAWING.</small>				

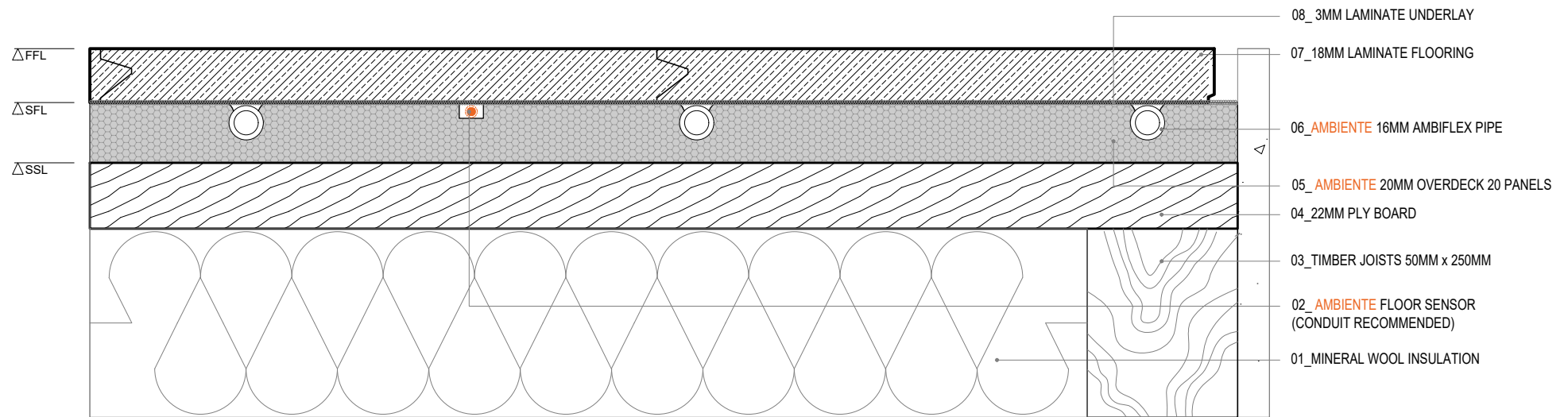

AMBIENTE OVERDECK 20. Laminate Floor Detail - Timber Subfloor

TITLE OVERDECK 20 - Laminate Floor Detail - Timber Subfloor		CAD FILE 20250804-OVERDECK 20-DET SECTIONS.DWG		 <p> <small> AMBIENTE SYSTEMS LIMITED HERITAGE HOUSE, UNIT 1 WOODSIDE LANE, BELL BAR, HERTFORDSHIRE, AL9 6DE SALES@AMBIENTEUFH.CO.UK T.01707 649 118 </small> </p>
DRAWN VL	CHECKED GC	DATE 04.08.2025	SCALE N/A	
<small>THIS FILE AND ITS CONTENT ARE THE PROPERTY OF AMBIENTE SYSTEMS LIMITED AND ARE PROTECTED BY COPYRIGHT LAWS. THIS FILE AND ITS CONTENTS MAY ONLY BE DISTRIBUTED, COPIED OR REPRODUCED IN FULL AND MAY NOT BE EDITED OR COPIED IN PART. DO NOT SCALE FROM THIS DRAWING.</small>				

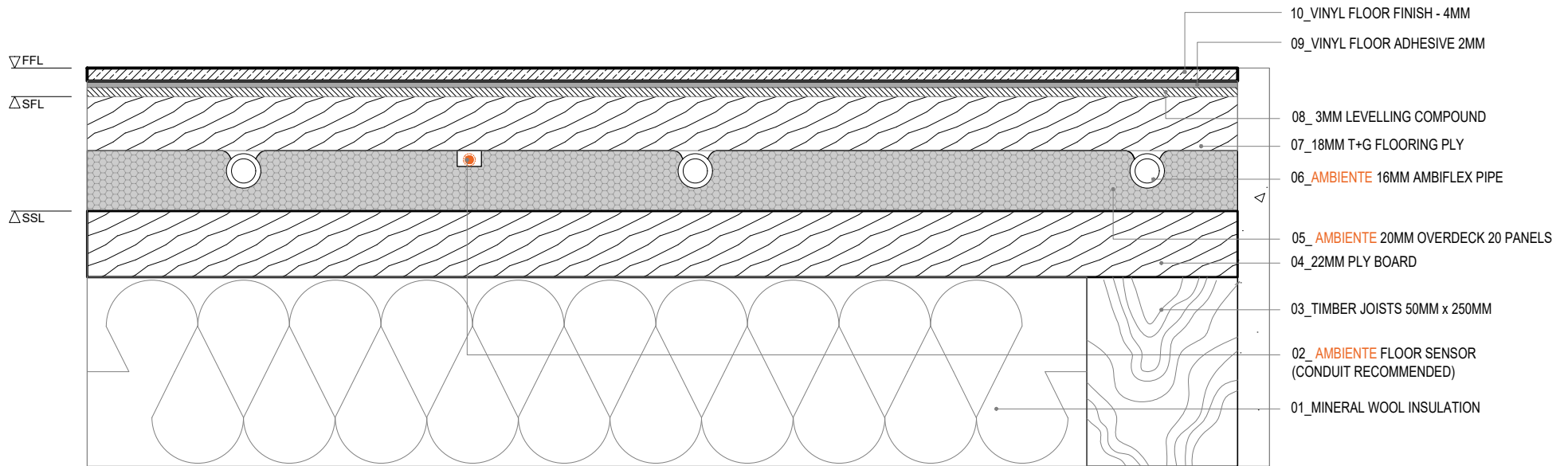

AMBIENTE OVERDECK 20. Vinyl Floor Finish - Timber Subfloor

TITLE
 OVERDECK 20 - Vinyl Floor Finish - Timber Subfloor

CAD FILE
 20250804-OVERDECK 20-DET SECTIONS.DWG

DRAWN
 VL

CHECKED
 GC

DATE
 04.08.2025

SCALE
 N/A



AMBIENTE SYSTEMS LIMITED
 HERITAGE HOUSE, UNIT 1 WOODSIDE LANE, BELL BAR, HERTFORDSHIRE, AL9 6DE
 SALES@AMBIENTEUFH.CO.UK
 T.01707 649 118

THIS FILE AND ITS CONTENT ARE THE PROPERTY OF AMBIENTE SYSTEMS LIMITED AND ARE PROTECTED BY COPYRIGHT LAWS. THIS FILE AND ITS CONTENTS MAY ONLY BE DISTRIBUTED, COPIED OR REPRODUCED IN FULL AND MAY NOT BE EDITED OR COPIED IN PART.
 DO NOT SCALE FROM THIS DRAWING.

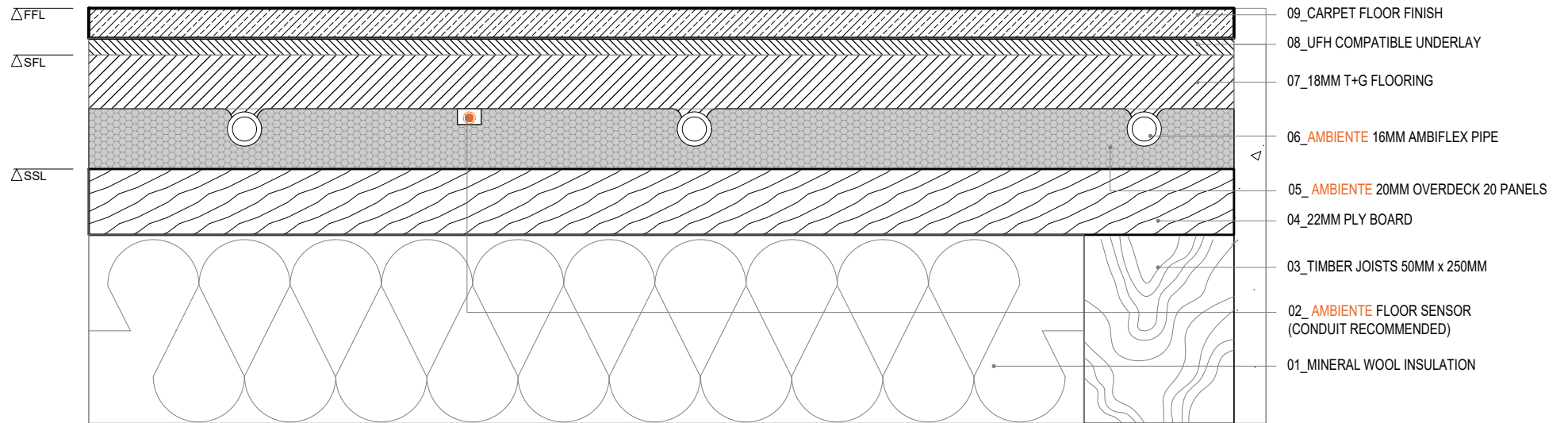

AMBIENTE OVERDECK 20. Carpet Floor Finish - Timber Subfloor

TITLE
OVERDECK 20 - Carpet Floor Finish- Timber Subfloor

CAD FILE
20250804-OVERDECK 20-DET SECTIONS.DWG

DRAWN
VL

CHECKED
GC

DATE
04.08.2025

SCALE
N/A



AMBIENTE SYSTEMS LIMITED
 HERITAGE HOUSE, UNIT 1 WOODSIDE LANE, BELL BAR, HERTFORDSHIRE, AL9 6DE
 SALES@AMBIENTEUFH.CO.UK
 T.01707 649 118